



**ASHWORTH**  
PEOPLE - PRODUCTS - SERVICE

# PIPE HANGING SYSTEMS PRODUCT GUIDE



**Issue July 2021**

[www.ashworth.uk.com](http://www.ashworth.uk.com)



# ASHWORTH

Suppliers of Pipe & Drainage Systems, Valves, Bracketry & Associated Products



## People

The key strength within our business are our colleagues. Due to the vast product ranges we supply, the importance of correct product selection and goods that are delivered safely and complete we highly value industry experience and therefore recruit the best.

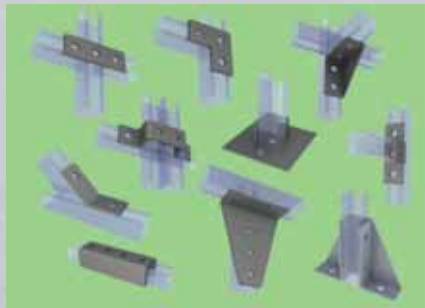

## Products

Operating within the Mechanical, Public Health, Industrial and Process markets require us to stock and supply high quality branded products suitable for critical applications. We operate to ISO9001, ISO14001 and are registered under the Achilles® Supply Chain Management scheme.



## Service

Our transport fleet operate to FORS Silver and our vehicles are equipped with HIAB off-loading facilities complete with all the latest health & safety equipment to safely convey material to site. The lorries are specified with Euro 6 engines that meet the stringent London low emission zone standards.

## Contents

	Page
<b>Channel Brackets &amp; Fittings</b>	<b>3-5</b>
<b>Pipe Supports</b>	<b>6</b>
<b>Channel</b>	<b>7</b>
<b>Plastic Pipe Fittings</b>	<b>8</b>
<b>Insulating Blocks</b>	<b>8-9</b>
<b>General Fasteners</b>	<b>10-11</b>
<b>Malleable Iron Fittings</b>	<b>12</b>
<b>Brass Fittings</b>	<b>12</b>
<b>Fire Protection</b>	<b>13</b>
<b>Flat Roof Support</b>	<b>13</b>
<b>Pipe &amp; Drainage Systems, Valves, Bracketry &amp; Associated Products</b>	<b>14</b>
<b>Key Suppliers</b>	<b>15</b>













E&OE

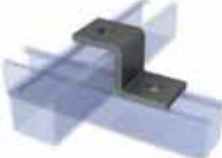

**ASHWORTH**  
PEOPLE - PRODUCTS - SERVICE

## CHANNEL BRACKETS & FITTINGS

All product codes are prefixed 1960















PRODUCT CODE	DESCRIPTION	PRODUCT CODE	DESCRIPTION	PRODUCT CODE	DESCRIPTION
					
A201	SQUARE WASHER	A210	FLAT PLATE 'L' TYPE 3 HOLE	A230	Z BRACKET
3001	M8 A201 SQUARE WASHER	3040	A210 FLAT PLATE 'L' TYPE 3 HOLE	3075	41x21 A230 Z BRACKET
3002	M10 A201 SQUARE WASHER				
3003	M12 A201 SQUARE WASHER	A202	FLAT PLATE 2 HOLE	A231	Z BRACKET
3020	A202 FLAT PLATE 2 HOLE	3045	A215 FLAT PLATE 'T' TYPE 4 HOLE	3080	41x41 A231 Z BRACKET
					
A203	FLAT PLATE 3 HOLE	A220	TOP HAT	A232	Z BRACKET
3025	A203 FLAT PLATE 3 HOLE	3050	41x41 A220 TOP HAT	3085	82x41 A232 Z BRACKET
		3051	41x21 A220 TOP HAT		
A204	FLAT PLATE 4 HOLE	A222	TALL TOP HAT	A241	EXT ANGLE BRACKET
3030	A204 FLAT PLATE 4 HOLE	3060	82x42 A222 TALL TOP HAT	3100	45deg A241 EXT ANGLE BRACKET - SINGLE HOLES
					
A205	FLAT PLATE 5 HOLE	A225	EXTERNAL SPLICE	AB19	INT ANGLE BRACKET
3035	A205 FLAT PLATE 5 HOLE	3065	41x41 A225 EXTERNAL SPLICE	3110	45deg AB19 INT ANGLE BRACKET

CHANNEL BRACKETS & FITTINGS



## CHANNEL BRACKETS &amp; FITTINGS

All product codes are prefixed 1960

PRODUCT CODE	DESCRIPTION	PRODUCT CODE	DESCRIPTION	PRODUCT CODE	DESCRIPTION
					
3120	A245 REINFORCED ANGLE BRACKET	3160	A270L 90deg LEFT SIDE WING BRACKET	3200	A288 DELTA FLOOR FIXING
					
3125	A250 ANGLE BRACKET 2 HOLE (50x47)	3170	A271R 90deg RIGHT SIDE WING BRACKET	3205	A290 DOUBLE DELTA FLOOR FIXING
3130	A251 ANGLE BRACKET 2 HOLE (57x41)				
					
3135	A255 ANGLE BRACKET 3 HOLE (41x104)	3185	A280 SINGLE STRUT BASE PLATE	3210	A292 TOWER FIXING
3136	A256 ANGLE BRACKET 3 HOLE (47x98)				
					
3145	A260 ANGLE BRACKET 4 HOLE (2/2)	3190	A282 DOUBLE STRUT BASE PLATE	3215	A295L LARGE 90deg ANGLE/DELTA FIXING
					
3150	A261 ANGLE BRACKET 4 HOLE (3/1)	3195	A284 CENTRAL FIX BASE PLATE	3220	A295S SMALL 90deg ANGLE/DELTA FIXING

## CHANNEL BRACKETS & FITTINGS

All product codes are prefixed 1960

PRODUCT DESCRIPTION  
CODE

PRODUCT DESCRIPTION  
CODE

PRODUCT DESCRIPTION  
CODE



A301 WINDOW BRACKET

- 3225 41x21 A301 WINDOW BRACKET
- 3226 41x41 A301 WINDOW BRACKET
- 3227 41x82 A301 WINDOW BRACKET



A320 RIDGED BEAM CLEAT

- 3250 A320 RIDGED BEAM CLEAT

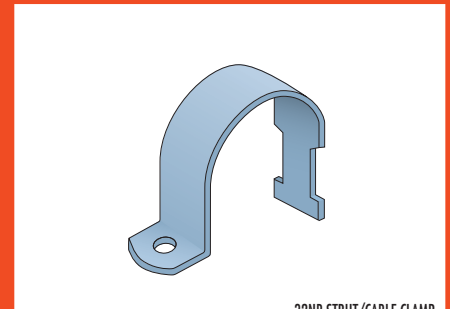

32NB STRUT/CABLE CLAMP

- 3503 32NB (43 OD) STRUT/CABLE CLAMP
- 3511 200NB (219 OD) STRUT/CABLE CLAMP



A305 GIRDER PLATE

- 3231 41x41 A305 GIRDER PLATE c/w SQUARE U-BOLT



A330 PURLIN CLIP (12mm HOLE)

- 3270 M10 A330 PURLIN CLIP (12mm HOLE)

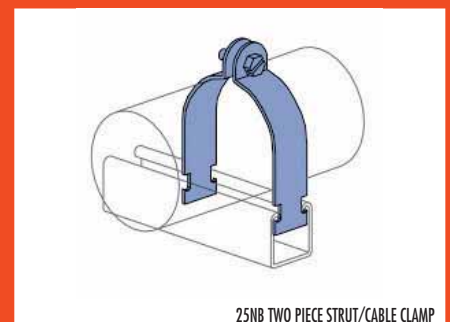

25NB TWO PIECE STRUT/CABLE CLAMP

- 3550 25NB (31.8 - 35.9 OD) TWO PIECE STRUT/CABLE CLAMP
- 3555 32NB (39.7 - 42.9 OD) TWO PIECE STRUT/CABLE CLAMP
- 3560 40NB (46.8 - 50.8 OD) TWO PIECE STRUT/CABLE CLAMP
- 3565 50NB (58.7 - 63.5 OD) TWO PIECE STRUT/CABLE CLAMP
- 3570 65NB (73.0 - 79.4 OD) TWO PIECE STRUT/CABLE CLAMP
- 3575 80NB (88.1 - 95.2 OD) TWO PIECE STRUT/CABLE CLAMP
- 3580 100NB (111.1 - 120.7 OD) TWO PIECE STRUT/CABLE CLAMP
- 3585 125NB (138.1 - 149.2 OD) TWO PIECE STRUT/CABLE CLAMP
- 3590 150NB (161.9 - 174.6 OD) TWO PIECE STRUT/CABLE CLAMP



A310 Z BEAM CLAMP TAPPED M10

- 3235 A310 Z BEAM CLAMP TAPPED M10



FL210P FLANGE CLAMP (FL210P)

- 3276 M10 FLANGE CLAMP (FL210P)
- 3277 M12 FLANGE CLAMP (FL312P)



M10 AW LINDAPTER ALPHAWEDGE

- 3702 M10 AW LINDAPTER ALPHAWEDGE
- 3722 M10 MW2 LINDAPTER MULTIWEDGE 2
- 3762 M10 TR60 LINDAPTER WEDGE



A312 SMALL BEAM CLAMP TAPPED M10

- 3240 A312 SMALL BEAM CLAMP TAPPED M10



A3150/A3300/A3450/A3600/A3750 SINGLE CANTILEVER ARM

- 3300 A3150 SINGLE CANTILEVER ARM 150mm LONG
- 3301 A3300 SINGLE CANTILEVER ARM 300mm LONG
- 3302 A3450 SINGLE CANTILEVER ARM 450mm LONG
- 3303 A3600 SINGLE CANTILEVER ARM 600mm LONG
- 3304 A3750 SINGLE CANTILEVER ARM 750mm LONG



A315 LARGE BEAM CLAMP TAPPED M10

- 3245 A315 LARGE BEAM CLAMP TAPPED M10



M10 TC10 LINDAPTER TOGGLE CLAMP

- 3781 M10 TC10 LINDAPTER TOGGLE CLAMP
- 3800 M10 WF LINDAPTER WEBFIX

CHANNEL BRACKETS & FITTINGS

## PIPE SUPPORTS

All product codes are prefixed 1960

PRODUCT DESCRIPTION  
CODE

SPLIT BAND FOR STL PIPE

1600	15NB (21 OD) SPLIT BAND FOR STL PIPE ZINC PLTD (25x3 M6)
1601	20NB (27 OD) SPLIT BAND FOR STL PIPE ZINC PLTD (25x3 M6)
1602	25NB (34 OD) SPLIT BAND FOR STL PIPE ZINC PLTD (25x3 M6)
1603	32NB (42 OD) SPLIT BAND FOR STL PIPE ZINC PLTD (30x3 M10)
1604	40NB (48 OD) SPLIT BAND FOR STL PIPE ZINC PLTD (30x3 M10)
1605	50NB (63 OD) SPLIT BAND FOR STL PIPE ZINC PLTD (30x3 M10)
1662	73mm OD OVERSIZE SPLIT BAND ZINC PLTD (30x3 M10)
1664	65NB (77 OD) SPLIT BAND FOR STL PIPE ZINC PLTD (30x3 M10)
1666	81mm OD OVERSIZE SPLIT BAND ZINC PLTD (30x3 M10)
1668	83mm OD OVERSIZE SPLIT BAND ZINC PLTD (30x3 M10)
1672	80NB (89 OD) SPLIT BAND FOR STL PIPE ZINC PLTD (30x3 M10)
1676	96mm OD OVERSIZE SPLIT BAND ZINC PLTD (30x3 M10)
1682	106mm OD OVERSIZE SPLIT BAND ZINC PLTD (30x3 M10)
1686	100NB (114 OD) SPLIT BAND FOR STL PIPE ZINC PLTD (30x3 M10)
1690	122mm OD OVERSIZE SPLIT BAND ZINC PLTD (30x3 M10)
1692	127mm OD OVERSIZE SPLIT BAND ZINC PLTD (30x3 M10)
1696	139mm OD OVERSIZE SPLIT BAND ZINC PLTD (30x3 M10)
1698	125NB (143 OD) SPLIT BAND FOR STL PIPE ZINC PLTD
1702	148mm OD OVERSIZE SPLIT BAND ZINC PLTD (30x3 M10)
1706	152mm OD OVERSIZE SPLIT BAND ZINC PLTD (40x3 M10)
1708	155mm OD OVERSIZE SPLIT BAND ZINC PLTD (40x3 M12)
1710	159mm OD OVERSIZE SPLIT BAND ZINC PLTD (40x3 M12)
1712	163mm OD OVERSIZE SPLIT BAND ZINC PLTD (40x3 M12)
1714	150NB (168 OD) SPLIT BAND FOR STL PIPE ZINC PLTD
1716	173mm OD OVERSIZE SPLIT BAND ZINC PLTD
1718	176mm OD OVERSIZE SPLIT BAND ZINC PLTD (40x3 M12)
1720	180mm OD OVERSIZE SPLIT BAND ZINC PLTD (40x5 M12)
1722	183mm OD OVERSIZE SPLIT BAND ZINC PLTD (40x5 M12)
1726	190mm OD OVERSIZE SPLIT BAND ZINC PLTD (40x5 M12)
1728	193mm OD OVERSIZE SPLIT BAND ZINC PLTD
1730	199mm OD OVERSIZE SPLIT BAND ZINC PLTD
1734	202mm OD OVERSIZE SPLIT BAND ZINC PLTD (40x5 M12)
1738	212mm OD OVERSIZE SPLIT BAND ZINC PLTD
1742	216mm OD OVERSIZE SPLIT BAND ZINC PLTD
1744	200NB (220 OD) SPLIT BAND FOR STL PIPE ZINC PLTD
1748	232mm OD OVERSIZE SPLIT BAND ZINC PLTD
1752	236mm OD OVERSIZE SPLIT BAND ZINC PLTD (40x5 M12)
1754	240mm OD OVERSIZE SPLIT BAND ZINC PLTD
1758	250mm OD OVERSIZE SPLIT BAND ZINC PLTD (40x5 M12)
1760	252mm OD OVERSIZE SPLIT BAND ZINC PLTD (40x5 M12)
1762	260mm OD OVERSIZE SPLIT BAND ZINC PLTD (40x5 M12)
1768	270mm OD OVERSIZE SPLIT BAND ZINC PLTD
1772	250NB (275 OD) SPLIT BAND FOR STL PIPE ZINC PLTD (40x5 M12)
1780	289mm OD OVERSIZE SPLIT BAND ZINC PLTD (40x5 M12)
1784	302mm OD OVERSIZE SPLIT BAND ZINC PLTD (40x5 M12)
1792	300NB (325 OD) SPLIT BAND FOR STL PIPE ZINC PLTD (40x5 M12)



SADDLE CLAMP FOR STL PIPE ZINC PLTD

1820	15NB (21 OD) SADDLE CLAMP FOR STL PIPE ZINC PLTD
1822	25NB (34 OD) SADDLE CLAMP FOR STL PIPE ZINC PLTD
1824	40NB (48 OD) SADDLE CLAMP FOR STL PIPE ZINC PLTD
1825	50NB (60 OD) SADDLE CLAMP FOR STL PIPE ZINC PLTD
1827	80NB (89 OD) SADDLE CLAMP FOR STL PIPE ZINC PLTD
1828	100NB (114 OD) SADDLE CLAMP FOR STL PIPE ZINC PLTD
1829	125NB (140 OD) SADDLE CLAMP FOR STL PIPE ZINC PLTD

PRODUCT DESCRIPTION  
CODE

ZINC PLATED U-BOLT

1850	15 (M6 THREAD) ZINC PLATED U-BOLT
1851	20 (M6 THREAD) ZINC PLATED U-BOLT
1852	25 (M6 THREAD) ZINC PLATED U-BOLT
1853	32 (M10 THREAD) ZINC PLATED U-BOLT
1854	40 (M10 THREAD) ZINC PLATED U-BOLT
1855	50 (M10 THREAD) ZINC PLATED U-BOLT
1856	65 (M10 THREAD) ZINC PLATED U-BOLT
1857	80 (M12 THREAD) ZINC PLATED U-BOLT
1858	100 (M12 THREAD) ZINC PLATED U-BOLT
1859	125 (M12 THREAD) ZINC PLATED U-BOLT
1860	150 (M12 THREAD) ZINC PLATED U-BOLT
1861	200 (M16 THREAD) ZINC PLATED U-BOLT
1862	250 (M16 THREAD) ZINC PLATED U-BOLT
1863	300 (M16 THREAD) ZINC PLATED U-BOLT
1881	32 (M10 THREAD) ZINC PLATED EXTENDED U-BOLT
1882	40 (M10 THREAD) ZINC PLATED EXTENDED U-BOLT
1883	50 (M10 THREAD) ZINC PLATED EXTENDED U-BOLT
1884	65 (M10 THREAD) ZINC PLATED EXTENDED U-BOLT
1885	80 (M12 THREAD) ZINC PLATED EXTENDED U-BOLT
1886	100 (M12 THREAD) ZINC PLATED EXTENDED U-BOLT
1887	125 (M12 THREAD) ZINC PLATED EXTENDED U-BOLT
1888	150 (M12 THREAD) ZINC PLATED EXTENDED U-BOLT



SUREFIX UNLINED CLIP

2008	38-42mm UNLINED FASTFIX CLAMP M10 TAPPING
2012	54mm SUREFIX UNLINED CLIP (54-58) M8/M10 DUAL TAPPING
2014	62-68mm UNLINED FASTFIX CLAMP M10 TAPPING
2018	79-85mm UNLINED FASTFIX CLAMP M10 TAPPING
2020	85-89mm UNLINED FASTFIX CLAMP M10 TAPPING
2024	100-105mm UNLINED FASTFIX CLAMP M10 TAPPING
2028	110-118mm UNLINED FASTFIX CLAMP M10 TAPPING
2030	116-125mm SUREFIX UNLINED CLIP M8/M10 DUAL TAPPING
2034	129-141mm SUREFIX UNLINED CLIP M8/M10 DUAL TAPPING
2036	139-144mm UNLINED FASTFIX CLAMP M10 TAPPING
2038	146-151mm UNLINED FASTFIX CLAMP M10 TAPPING
2040	155mm UNLINED FASTFIX CLAMP M10 TAPPING
2044	166-177mm SUREFIX UNLINED CLIP M8/M10 DUAL TAPPING
2046	173-183mm UNLINED QUICK LOCK CLAMP M10 TAPPING (3023180)
2048	180-190mm UNLINED QUICK LOCK CLAMP M10 TAPPING (3023190)
2052	212-219mm UNLINED QUICK LOCK CLAMP M10 TAPPING (3023219)
2132	212-219mm UNLINED FASTFIX CLAMP M10 TAPPING
2160	15-17mm UNLINED 2-SCREW CLAMP M8/M10 DUAL TAPPING
2161	1/2" SUREFIX UNLINED CLIP (19-23) M8/M10 DUAL TAPPING
2162	3/4" SUREFIX UNLINED CLIP (26-30) M8/M10 DUAL TAPPING
2163	1" SUREFIX UNLINED CLIP (32-35) M8/M10 DUAL TAPPING
2164	1.1/4" SUREFIX UNLINED CLIP (39-43) M8/M10 DUAL TAPPING
2165	1.1/2" SUREFIX UNLINED CLIP (45-51) M8/M10 DUAL TAPPING
2166	2" SUREFIX UNLINED CLIP (60-65) M8/M10 DUAL TAPPING
2167	67-71mm SUREFIX UNLINED CLIP M8/M10 DUAL TAPPING
2168	2.1/2" SUREFIX UNLINED CLIP (74-82) M8/M10 DUAL TAPPING
2169	75mm SUREFIX UNLINED CLIP (82-89) M8/M10 DUAL TAPPING
2170	3" SUREFIX UNLINED CLIP (91-98) M8/M10 DUAL TAPPING
2172	93-101mm SUREFIX UNLINED CLIP M8/M10 DUAL TAPPING
2173	102-109mm SUREFIX UNLINED CLIP M8/M10 DUAL TAPPING

PRODUCT DESCRIPTION  
CODE

2174	4" SUREFIX UNLINED CLIP (109-117) M8/M10 DUAL TAPPING
2175	5" SUREFIX UNLINED CLIP (136-146) M8/M10 DUAL TAPPING
2176	6" SUREFIX UNLINED CLIP (158-169) M8/M10 DUAL TAPPING
2177	122-127mm UNLINED 2-SCREW CLAMP M8/M10 DUAL TAPPING
2178	142-154mm SUREFIX UNLINED CLIP M8/M10 DUAL TAPPING
2179	155mm UNLINED 2-SCREW CLAMP M10 TAPPING



SUREFIX XL RUBBER LINED CLIP

2102	15cu SUREFIX XL RUBBER LINED CLIP (1/4" 13-20) M8/M10 DUAL TAPPING
2104	22cu SUREFIX XL RUBBER LINED CLIP (1/2" 21-26) M8/M10 DUAL TAPPING
2106	28cu SUREFIX XL RUBBER LINED CLIP (3/4" 26-30) M8/M10 DUAL TAPPING
2108	35cu SUREFIX XL RUBBER LINED CLIP (1" 33-37) M8/M10 DUAL TAPPING
2110	42cu SUREFIX XL RUBBER LINED CLIP (1.1/4" 40-46) M8/M10 DUAL TAPPING
2112	44-49mm BLACK RUBBER LINED 2-SCREW CLAMP M8/M10 DUAL TAPPING
2114	1.1/2" SUREFIX XL RUBBER LINED CLIP (1.1/2" 48-53) M8/M10 DUAL TAPPING
2116	54cu SUREFIX XL RUBBER LINED CLIP (53-59) M8/M10 DUAL TAPPING
2118	2" SUREFIX XL RUBBER LINED CLIP (2" 60-66) M8/M10 DUAL TAPPING
2119	67cu SUREFIX XL RUBBER LINED CLIP (67-77) M8/M10 DUAL TAPPING
2120	76cu SUREFIX XL RUBBER LINED CLIP (2.1/2" 75-84) M8/M10 DUAL TAPPING
2122	3" SUREFIX XL RUBBER LINED CLIP (83-93) M8/M10 DUAL TAPPING
2124	4" SUREFIX XL RUBBER LINED CLIP (109-119) M8/M10 DUAL TAPPING
2126	133cu SUREFIX XL RUBBER LINED CLIP (128-139) M8/M10 DUAL TAPPING
2128	5" SUREFIX XL RUBBER LINED CLIP (135-148) M8/M10 DUAL TAPPING
2130	6" SUREFIX XL RUBBER LINED CLIP (158-170) M8/M10 DUAL TAPPING

## SADDLE CLAMP

2254	28 SADDLE CLAMP FOR COPPER PIPE NYLON COATED
2258	42 SADDLE CLAMP FOR COPPER PIPE NYLON COATED



FILBOW CLAMP

2302	25 FILBOW CLAMP FM APPROVED
2303	32 FILBOW CLAMP FM APPROVED
2304	40 FILBOW CLAMP FM APPROVED
2305	50 FILBOW CLAMP FM APPROVED
2307	80 FILBOW CLAMP FM APPROVED
2308	100 FILBOW CLAMP FM APPROVED
2310	150 FILBOW CLAMP FM APPROVED



## CHANNEL

All product codes are prefixed 1960

PRODUCT DESCRIPTION  
CODE



PRE-GALV SLOTTED CHANNEL

0000	21x41 A21S6 PRE-GALV SLOTTED CHANNEL 6Mtr LENGTH x 2.5mm THICK
0001	21x41 A21S3 PRE-GALV SLOTTED CHANNEL 3Mtr LENGTH x 2.5mm THICK
0002	21x41 A21S2 PRE-GALV SLOTTED CHANNEL 2Mtr LENGTH x 2.5mm THICK
0006	21x41 A21LS3 LIGHT PRE-GALV SLOTTED CHANNEL 3Mtr LENGTH x 1.5mm THICK
0010	41x41 A41S6 PRE-GALV SLOTTED CHANNEL 6Mtr LENGTH x 2.5mm THICK
0011	41x41 A41S3 PRE-GALV SLOTTED CHANNEL 3Mtr LENGTH x 2.5mm THICK
0015	41x41 A41LS6 LIGHT PRE-GALV SLOTTED CHANNEL 6Mtr LENGTH x 1.5mm THICK
0016	41x41 A41LS3 LIGHT PRE-GALV SLOTTED CHANNEL 3Mtr LENGTH x 1.5mm THICK

PRODUCT DESCRIPTION  
CODE



PRE-GALV PLAIN CHANNEL

0040	21x41 A21P6 PRE-GALV PLAIN CHANNEL 6Mtr LENGTH x 2.5mm THICK
0060	41x41 A41P6 PRE-GALV PLAIN CHANNEL 6Mtr LENGTH x 2.5mm THICK
0061	41x41 A41P3 PRE-GALV PLAIN CHANNEL 3Mtr LENGTH x 2.5mm THICK



PRE-GALV SLOTTED BACKTOBACK CHANNEL

0074	41x41 A41B2BS6 PRE-GALV SLOT BACKTOBACK CHANNEL 6Mtr LEN x 2.5mm THICK
0075	41x41 A41B2BS3 PRE-GALV SLOT BACKTOBACK CHANNEL 3Mtr LEN x 2.5mm THICK
0080	41x41 A41B2BP6 PREGALV PLAIN BACKTOBACK CHANNEL 6Mtr LEN x 2.5mm THICK

PRODUCT DESCRIPTION  
CODE

### CLOSURE STRIP

0090	PVC CLOSURE STRIP FOR CHANNEL IN 3 Mtr LENGTHS
------	--

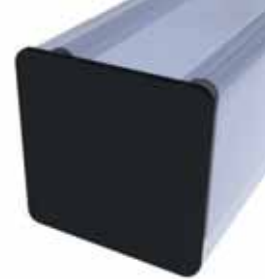

CHANNEL END CAP - BLACK

3265	41 A325 CHANNEL END CAP - BLACK
3266	21 A325 CHANNEL END CAP - BLACK



PLASTIC END CAP FOR STUDDING

3267	M10 PLASTIC END CAP FOR STUDDING
3268	M12 PLASTIC END CAP FOR STUDDING
3269	M16 PLASTIC END CAP FOR STUDDING

CHANNEL

## PLASTIC FITTINGS

All product codes are prefixed 1960



PRODUCT DESCRIPTION  
CODE

### PUSH-IN PLASTIC CLIP

6440	15 A651 PUSH-IN PLASTIC CLIP
6441	22 A651 PUSH-IN PLASTIC CLIP
6442	28 A651 PUSH-IN PLASTIC CLIP

### WRAP OVER PLASTIC CLIP

6480	15 A653 WRAP OVER PLASTIC CLIP
6481	22 A653 WRAP OVER PLASTIC CLIP
6482	28 A653 WRAP OVER PLASTIC CLIP

### NAIL-IN PLASTIC CLIP

6500	15 A654 NAIL-IN PLASTIC CLIP
6501	22 A654 NAIL-IN PLASTIC CLIP
6502	28 A654 NAIL-IN PLASTIC CLIP

### SNAP-OVER PLASTIC CLIP

6520	15 A655 SNAP-OVER PLASTIC CLIP
6521	22 A655 SNAP-OVER PLASTIC CLIP
6522	28 A655 SNAP-OVER PLASTIC CLIP

### DOUBLE SNAP-OVER PLASTIC CLIP

6540	15 A656 DOUBLE SNAP-OVER PLASTIC CLIP
6541	22 A656 DOUBLE SNAP-OVER PLASTIC CLIP
6542	28 A656 DOUBLE SNAP-OVER PLASTIC CLIP

PLASTIC FITTINGS



## INSULATING BLOCKS

All product codes are prefixed 1960

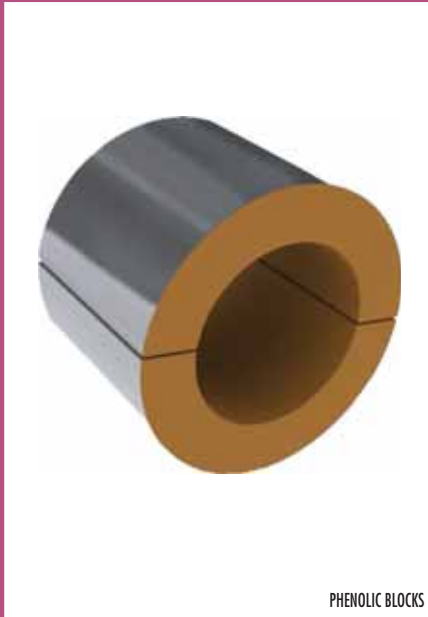
PRODUCT DESCRIPTION  
CODEPRODUCT DESCRIPTION  
CODEPRODUCT DESCRIPTION  
CODE

PHENOLIC BLOCKS

4000	15C PHENOLIC BLOCKS 15mm THICK
4001	15S/22C PHENOLIC BLOCKS 15mm THICK
4002	20S/28C PHENOLIC BLOCKS 15mm THICK
4003	25S/35C PHENOLIC BLOCKS 15mm THICK
4004	32S/42C PHENOLIC BLOCKS 15mm THICK
4005	40S PHENOLIC BLOCKS 15mm THICK
4006	50S PHENOLIC BLOCKS 15mm THICK
4007	54C PHENOLIC BLOCKS 15mm THICK
4008	67C PHENOLIC BLOCKS 15mm THICK
4010	80S PHENOLIC BLOCKS 15mm THICK
4012	108C PHENOLIC BLOCKS 15mm THICK
4016	15C PHENOLIC BLOCKS 20mm THICK
4017	15S/22C PHENOLIC BLOCKS 20mm THICK
4018	20S/28C PHENOLIC BLOCKS 20mm THICK
4019	25S/35C PHENOLIC BLOCKS 20mm THICK
4020	32S/42C PHENOLIC BLOCKS 20mm THICK
4021	40S PHENOLIC BLOCKS 20mm THICK
4022	50S PHENOLIC BLOCKS 20mm THICK
4023	54C PHENOLIC BLOCKS 20mm THICK
4024	67C PHENOLIC BLOCKS 20mm THICK
4025	65S/76C PHENOLIC BLOCKS 20mm THICK
4028	108C PHENOLIC BLOCKS 20mm THICK
4029	125S PHENOLIC BLOCKS 20mm THICK
4032	15C PHENOLIC BLOCKS 25mm THICK
4033	15S/22C PHENOLIC BLOCKS 25mm THICK
4034	20S/28C PHENOLIC BLOCKS 25mm THICK
4035	25S/35C PHENOLIC BLOCKS 25mm THICK
4036	32S/42C PHENOLIC BLOCKS 25mm THICK
4037	40S PHENOLIC BLOCKS 25mm THICK
4038	50S PHENOLIC BLOCKS 25mm THICK
4039	54C PHENOLIC BLOCKS 25mm THICK
4040	67C PHENOLIC BLOCKS 25mm THICK
4041	65S/76C PHENOLIC BLOCKS 25mm THICK
4042	80S PHENOLIC BLOCKS 25mm THICK
4043	100S PHENOLIC BLOCKS 25mm THICK
4044	108C PHENOLIC BLOCKS 25mm THICK
4045	125S PHENOLIC BLOCKS 25mm THICK
4046	150S PHENOLIC BLOCKS 25mm THICK
4047	159C PHENOLIC BLOCKS 25mm THICK
4048	15C PHENOLIC BLOCKS 30mm THICK
4049	15S/22C PHENOLIC BLOCKS 30mm THICK
4050	20S/28C PHENOLIC BLOCKS 30mm THICK
4051	25S/35C PHENOLIC BLOCKS 30mm THICK
4052	32S/42C PHENOLIC BLOCKS 30mm THICK
4053	40S PHENOLIC BLOCKS 30mm THICK
4054	50S PHENOLIC BLOCKS 30mm THICK
4055	54C PHENOLIC BLOCKS 30mm THICK
4056	67C PHENOLIC BLOCKS 30mm THICK
4057	65S/76C PHENOLIC BLOCKS 30mm THICK
4058	80S PHENOLIC BLOCKS 30mm THICK

4059	100S PHENOLIC BLOCKS 30mm THICK
4060	108C PHENOLIC BLOCKS 30mm THICK
4061	125S PHENOLIC BLOCKS 30mm THICK
4062	150S PHENOLIC BLOCKS 30mm THICK
4064	15C PHENOLIC BLOCKS 40mm THICK
4065	15S/22C PHENOLIC BLOCKS 40mm THICK
4066	20S/28C PHENOLIC BLOCKS 40mm THICK
4067	25S/35C PHENOLIC BLOCKS 40mm THICK
4068	32S/42C PHENOLIC BLOCKS 40mm THICK
4069	40S PHENOLIC BLOCKS 40mm THICK
4070	50S PHENOLIC BLOCKS 40mm THICK
4071	54C PHENOLIC BLOCKS 40mm THICK
4073	65S/76C PHENOLIC BLOCKS 40mm THICK
4074	80S PHENOLIC BLOCKS 40mm THICK
4075	100S PHENOLIC BLOCKS 40mm THICK
4078	150S PHENOLIC BLOCKS 40mm THICK
4080	15C PHENOLIC BLOCKS 50mm THICK
4081	15S/22C PHENOLIC BLOCKS 50mm THICK
4082	20S/28C PHENOLIC BLOCKS 50mm THICK
4083	25S/35C PHENOLIC BLOCKS 50mm THICK
4084	32S/42C PHENOLIC BLOCKS 50mm THICK
4085	40S PHENOLIC BLOCKS 50mm THICK
4086	50S PHENOLIC BLOCKS 50mm THICK
4087	54C PHENOLIC BLOCKS 50mm THICK
4089	65S/76C PHENOLIC BLOCKS 50mm THICK
4090	80S PHENOLIC BLOCKS 50mm THICK
4091	100S PHENOLIC BLOCKS 50mm THICK
4092	108C PHENOLIC BLOCKS 50mm THICK
4093	125S PHENOLIC BLOCKS 50mm THICK
4094	150S PHENOLIC BLOCKS 50mm THICK
4095	159C PHENOLIC BLOCKS 50mm THICK



HARDWOOD BLOCKS

4200	15C HARDWOOD BLOCKS 15mm THICK
4201	15S/22C HARDWOOD BLOCKS 15mm THICK
4202	20S/28C HARDWOOD BLOCKS 15mm THICK
4203	25S/35C HARDWOOD BLOCKS 15mm THICK
4204	32S/42C HARDWOOD BLOCKS 15mm THICK
4205	40S HARDWOOD BLOCKS 15mm THICK
4206	50S HARDWOOD BLOCKS 15mm THICK
4207	54C HARDWOOD BLOCKS 15mm THICK
4208	67C HARDWOOD BLOCKS 15mm THICK
4209	65S/76C HARDWOOD BLOCKS 15mm THICK
4210	80S HARDWOOD BLOCKS 15mm THICK
4211	100S HARDWOOD BLOCKS 15mm THICK
4212	108C HARDWOOD BLOCKS 15mm THICK
4213	125S HARDWOOD BLOCKS 15mm THICK
4214	150S HARDWOOD BLOCKS 15mm THICK
4215	159C HARDWOOD BLOCKS 15mm THICK
4216	15C HARDWOOD BLOCKS 20mm THICK
4217	15S/22C HARDWOOD BLOCKS 20mm THICK

4218	20S/28C HARDWOOD BLOCKS 20mm THICK
4219	25S/35C HARDWOOD BLOCKS 20mm THICK
4220	32S/42C HARDWOOD BLOCKS 20mm THICK
4221	40S HARDWOOD BLOCKS 20mm THICK
4222	50S HARDWOOD BLOCKS 20mm THICK
4223	54C HARDWOOD BLOCKS 20mm THICK
4224	67C HARDWOOD BLOCKS 20mm THICK
4225	65S/76C HARDWOOD BLOCKS 20mm THICK
4226	80S HARDWOOD BLOCKS 20mm THICK
4227	100S HARDWOOD BLOCKS 20mm THICK
4228	108C HARDWOOD BLOCKS 20mm THICK
4229	125S HARDWOOD BLOCKS 20mm THICK
4230	150S HARDWOOD BLOCKS 20mm THICK
4231	159C HARDWOOD BLOCKS 20mm THICK
4232	15C HARDWOOD BLOCKS 25mm THICK
4233	15S/22C HARDWOOD BLOCKS 25mm THICK
4234	20S/28C HARDWOOD BLOCKS 25mm THICK
4235	25S/35C HARDWOOD BLOCKS 25mm THICK
4236	32S/42C HARDWOOD BLOCKS 25mm THICK
4237	40S HARDWOOD BLOCKS 25mm THICK
4238	50S HARDWOOD BLOCKS 25mm THICK
4239	54C HARDWOOD BLOCKS 25mm THICK
4240	67C HARDWOOD BLOCKS 25mm THICK
4241	65S/76C HARDWOOD BLOCKS 25mm THICK
4242	80S HARDWOOD BLOCKS 25mm THICK
4243	100S HARDWOOD BLOCKS 25mm THICK
4244	108C HARDWOOD BLOCKS 25mm THICK
4245	125S HARDWOOD BLOCKS 25mm THICK
4246	150S HARDWOOD BLOCKS 25mm THICK
4247	159C HARDWOOD BLOCKS 25mm THICK
4248	15C HARDWOOD BLOCKS 30mm THICK
4249	15S/22C HARDWOOD BLOCKS 30mm THICK
4250	20S/28C HARDWOOD BLOCKS 30mm THICK
4251	25S/35C HARDWOOD BLOCKS 30mm THICK
4252	32S/42C HARDWOOD BLOCKS 30mm THICK
4253	40S HARDWOOD BLOCKS 30mm THICK
4254	50S HARDWOOD BLOCKS 30mm THICK
4255	54C HARDWOOD BLOCKS 30mm THICK
4256	67C HARDWOOD BLOCKS 30mm THICK
4257	65S/76C HARDWOOD BLOCKS 30mm THICK
4258	80S HARDWOOD BLOCKS 30mm THICK
4259	100S HARDWOOD BLOCKS 30mm THICK
4260	108C HARDWOOD BLOCKS 30mm THICK
4261	125S HARDWOOD BLOCKS 30mm THICK
4262	150S HARDWOOD BLOCKS 30mm THICK
4263	159C HARDWOOD BLOCKS 30mm THICK
4264	15C HARDWOOD BLOCKS 40mm THICK
4265	15S/22C HARDWOOD BLOCKS 40mm THICK
4266	20S/28C HARDWOOD BLOCKS 40mm THICK
4267	25S/35C HARDWOOD BLOCKS 40mm THICK
4268	32S/42C HARDWOOD BLOCKS 40mm THICK
4269	40S HARDWOOD BLOCKS 40mm THICK
4270	50S HARDWOOD BLOCKS 40mm THICK
4271	54C HARDWOOD BLOCKS 40mm THICK
4272	67C HARDWOOD BLOCKS 40mm THICK
4273	65S/76C HARDWOOD BLOCKS 40mm THICK
4274	80S HARDWOOD BLOCKS 40mm THICK
4275	100S HARDWOOD BLOCKS 40mm THICK
4276	108C HARDWOOD BLOCKS 40mm THICK
4277	125S HARDWOOD BLOCKS 40mm THICK
4278	150S HARDWOOD BLOCKS 40mm THICK
4279	159C HARDWOOD BLOCKS 40mm THICK
4280	15C HARDWOOD BLOCKS 50mm THICK
4281	15S/22C HARDWOOD BLOCKS 50mm THICK
4282	20S/28C HARDWOOD BLOCKS 50mm THICK
4283	25S/35C HARDWOOD BLOCKS 50mm THICK
4284	32S/42C HARDWOOD BLOCKS 50mm THICK
4285	40S HARDWOOD BLOCKS 50mm THICK
4286	50S HARDWOOD BLOCKS 50mm THICK
4287	54C HARDWOOD BLOCKS 50mm THICK
4288	67C HARDWOOD BLOCKS 50mm THICK
4289	65S/76C HARDWOOD BLOCKS 50mm THICK
4290	80S HARDWOOD BLOCKS 50mm THICK
4291	100S HARDWOOD BLOCKS 50mm THICK
4292	108C HARDWOOD BLOCKS 50mm THICK
4293	125S HARDWOOD BLOCKS 50mm THICK
4294	150S HARDWOOD BLOCKS 50mm THICK
4295	159C HARDWOOD BLOCKS 50mm THICK





## INSULATING BLOCKS



STEEL (NB)	COPPER (OD)	PHENOLIC BLOCK THICKNESS						
SIZE	SIZE		15mm	20mm	25mm	30mm	40mm	50mm
	15mm	Phenolic Block	19604000	19604016	19604032	19604048	19604064	19604080
		Unlined Clip	19602162	19602012	19602167	19602168	19602170	19602174
15mm	22mm	Phenolic Block	19604001	19604017	19604033	19604049	19604065	19604081
		Unlined Clip	19602012	19602166	19602168	19602168	19602173	19602030
20mm	28mm	Phenolic Block	19604002	19604018	19604034	19604050	19604066	19604082
		Unlined Clip	19602166	19602167	19602168	19602169	19602173	19602034
25mm	35mm	Phenolic Block	19604003	19604019	19604035	19604051	19604067	19604083
		Unlined Clip	19602167	19602168	19602169	19602172	19602174	19602034
32mm	42mm	Phenolic Block	19604004	19604020	19604036	19604052	19604068	19604084
		Unlined Clip	19602168	19602169	19602170	19602173	19602030	19602175
40mm		Phenolic Block	19604005	19604021	19604037	19604053	19604069	19604085
		Unlined Clip	19602168	19602170	19602173	19602174	19602034	19602178
50mm		Phenolic Block	19604006	19604022	19604038	19604054	19604070	19604086
		Unlined Clip	19602170	19602173	19602174	19602030	19602178	19602176
	54mm	Phenolic Block	19604007	19604023	19604039	19604055	19604071	19604087
		Unlined Clip	19602169	19602170	19602173	19602174	19602034	19602178
	67mm	Phenolic Block	19604008	19604024	19604040	19604056	19604072	19604088
		Unlined Clip	19602172	19602174	19602030	19602034	19602178	19602176
65mm	76mm	Phenolic Block	19604009	19604025	19604041	19604057	19604073	19604089
		Unlined Clip	19602174	19602030	19602034	19602034	19602176	19602044
80mm		Phenolic Block	19604010	19604026	19604042	19604058	19604074	19604090
		Unlined Clip	19602030	19602034	19602175	19602178	19602044	19602048
100mm		Phenolic Block	19604011	19604027	19604043	19604059	19604075	19604091
		Unlined Clip	19602175	19602176	19602044	19602046	19602048	*
		Split Band	*	*	*	19601716	19601728	19601742
	108mm	Phenolic Block	19604012	19604028	19604044	19604060	19604076	19604092
		Unlined Clip	19602175	19602178	19602176	19602044	19602048	*
		Split Band	*	*	*	*	19601723	19601738
125mm		Phenolic Block	19604013	19604029	19604045	19604061	19604077	19604093
		Unlined Clip	19602042	19602046	19602048	19602050	19602052	*
		Split Band	19601716	19601719	19601728	19601730	19601744	19601754
150mm		Phenolic Block	19604014	19604030	19604046	19604062	19604078	19604094
		Unlined Clip	19602050	19602052	19602052	*	*	*
		Split Band	19601730	19601737	19601744	19601748	19601768	19601768
	159mm	Phenolic Block	*	19604031	19604047	19604063	19604079	19604095
		Unlined Clip	*	19602048	19602052	19602052	*	*
		Split Band	*	19601730	19601737	19601744	19601754	19601768

INSULATING BLOCKS

E&OE

## GENERAL FASTENERS

All product codes are prefixed 1960

PRODUCT DESCRIPTION  
CODE

HEXAGON NUT ZINC PLATED

0680	M6 HEXAGON NUT ZINC PLATED
0681	M8 HEXAGON NUT ZINC PLATED
0682	M10 HEXAGON NUT ZINC PLATED
0683	M12 HEXAGON NUT ZINC PLATED
0684	M16 HEXAGON NUT ZINC PLATED
0685	M20 HEXAGON NUT ZINC PLATED
0686	M24 HEXAGON NUT ZINC PLATED
0687	M27 HEXAGON NUT ZINC PLATED



SERRATED FLANGE NUT ZINC PLATED

0702	M10 SERRATED FLANGE NUT ZINC PLATED
0703	M12 SERRATED FLANGE NUT ZINC PLATED



FLAT WASHER ZINC PLATED

0720	M6 FLAT WASHER ZINC PLATED
0721	M8 FLAT WASHER ZINC PLATED
0722	M10 FLAT WASHER ZINC PLATED
0723	M12 FLAT WASHER ZINC PLATED
0724	M16 FLAT WASHER ZINC PLATED
0725	M20 FLAT WASHER ZINC PLATED
0726	M24 FLAT WASHER ZINC PLATED
0727	M27 FLAT WASHER ZINC PLATED



SPRING WASHER ZINC PLATED

0742	M10 SPRING WASHER ZINC PLATED
------	-------------------------------



PENNY WASHER ZINC PLATED

0754	M6x25 PENNY WASHER ZINC PLATED
0756	M8x25 PENNY WASHER ZINC PLATED
0758	M10x25 PENNY WASHER ZINC PLATED
0759	M10x30 PENNY WASHER ZINC PLATED
0760	M10x40 PENNY WASHER ZINC PLATED
0765	M12x40 PENNY WASHER ZINC PLATED

PRODUCT DESCRIPTION  
CODE

SCREWED ROD ZINC PLATED

0800	M6x1 Mtr SCREWED ROD ZINC PLATED
0802	M10x1 Mtr SCREWED ROD ZINC PLATED
0803	M12x1 Mtr SCREWED ROD ZINC PLATED
0804	M16x1 Mtr SCREWED ROD ZINC PLATED
0805	M20x1 Mtr SCREWED ROD ZINC PLATED
0806	M24x1 Mtr SCREWED ROD ZINC PLATED
0820	M6x3 Mtr SCREWED ROD ZINC PLATED
0821	M8x3 Mtr SCREWED ROD ZINC PLATED
0822	M10x3 Mtr SCREWED ROD ZINC PLATED
0823	M12x3 Mtr SCREWED ROD ZINC PLATED
0824	M16x3 Mtr SCREWED ROD ZINC PLATED
0825	M20x3 Mtr SCREWED ROD ZINC PLATED
0841	M10x25 THREADED STUD ZINC PLATED
0842	M10x50 THREADED STUD ZINC PLATED
0843	M10x40 THREADED STUD ZINC PLATED
0844	M10x60 THREADED STUD ZINC PLATED
0845	M10x80 THREADED STUD ZINC PLATED
0846	M10x100 THREADED STUD ZINC PLATED
0847	M10x120 THREADED STUD ZINC PLATED
0848	M10x150 THREADED STUD ZINC PLATED
0849	M10x200 THREADED STUD ZINC PLATED
0854	M12x60 THREADED STUD ZINC PLATED



ROD CONNECTOR ZINC PLATED

0860	M6 ROD CONNECTOR ZINC PLATED
0861	M8 ROD CONNECTOR ZINC PLATED
0862	M10 ROD CONNECTOR ZINC PLATED
0863	M12 ROD CONNECTOR ZINC PLATED
0864	M16 ROD CONNECTOR ZINC PLATED



REDUCING ROD CONNECTOR ZINC PLATED

0888	M12x10 (MxF) REDUCING ROD CONNECTOR ZINC PLATED
------	---



MALE ROD ADAPTOR ZINC PLATED

0910	M8 FEM x M10 MALE ROD ADAPTOR ZINC PLATED
0918	M10 FEM x M8 MALE ROD ADAPTOR ZINC PLATED
0922	M10 FEM x M12 MALE ROD ADAPTOR ZINC PLATED
0930	M12 FEM x M10 MALE ROD ADAPTOR ZINC PLATED

PRODUCT DESCRIPTION  
CODE

EYE BOLT ZINC PLATED

0960	M10x80 EYE BOLT ZINC PLATED
0964	M10x100 EYE BOLT ZINC PLATED
0972	M10x200 EYE BOLT ZINC PLATED
0980	M10x300 EYE BOLT ZINC PLATED
0984	M12x80 EYE BOLT ZINC PLATED
0988	M12x100 EYE BOLT ZINC PLATED
0992	M12x150 EYE BOLT ZINC PLATED
0996	M12x200 EYE BOLT ZINC PLATED



DROP IN CONCRETE ANCHOR

1020	M6 DROP IN CONCRETE ANCHOR
1021	M8 DROP IN CONCRETE ANCHOR
1022	M10 DROP IN CONCRETE ANCHOR
1023	M12 DROP IN CONCRETE ANCHOR
1024	M16 DROP IN CONCRETE ANCHOR
1026	M8/M10 SCREW IN CONCRETE ANCHOR (6x55)



PLAIN CHANNEL NUT

0200	M6 PLAIN CHANNEL NUT
0201	M8 PLAIN CHANNEL NUT
0202	M10 PLAIN CHANNEL NUT
0203	M12 PLAIN CHANNEL NUT



SHORT SPRING CHANNEL NUT

0220	M6 SHORT SPRING CHANNEL NUT
0222	M10 SHORT SPRING CHANNEL NUT
0223	M12 SHORT SPRING CHANNEL NUT



LONG SPRING CHANNEL NUT

0240	M6 LONG SPRING CHANNEL NUT
0241	M8 LONG SPRING CHANNEL NUT
0242	M10 LONG SPRING CHANNEL NUT
0243	M12 LONG SPRING CHANNEL NUT



## GENERAL FASTENERS

All product codes are prefixed 1960

PRODUCT DESCRIPTION  
CODE



HEX HEAD SET SCREW HIGH TENSILE 8.8 ZINC PLATED

0280	M10x20 HEX HEAD SET SCREW HIGH TENSILE 8.8 ZINC PLATED
0281	M10x25 HEX HEAD SET SCREW HIGH TENSILE 8.8 ZINC PLATED
0282	M10x30 HEX HEAD SET SCREW HIGH TENSILE 8.8 ZINC PLATED
0283	M10x40 HEX HEAD SET SCREW HIGH TENSILE 8.8 ZINC PLATED
0284	M10x50 HEX HEAD SET SCREW HIGH TENSILE 8.8 ZINC PLATED
0285	M10x60 HEX HEAD SET SCREW HIGH TENSILE 8.8 ZINC PLATED
0286	M10x70 HEX HEAD SET SCREW HIGH TENSILE 8.8 ZINC PLATED
0287	M10x80 HEX HEAD SET SCREW HIGH TENSILE 8.8 ZINC PLATED
0289	M10x100 HEX HEAD SET SCREW HIGH TENSILE 8.8 ZINC PLATED
0291	M10x45 HEX HEAD SET SCREW HIGH TENSILE 8.8 ZINC PLATED
0300	M12x25 HEX HEAD SET SCREW HIGH TENSILE 8.8 ZINC PLATED
0301	M12x30 HEX HEAD SET SCREW HIGH TENSILE 8.8 ZINC PLATED
0302	M12x40 HEX HEAD SET SCREW HIGH TENSILE 8.8 ZINC PLATED
0303	M12x50 HEX HEAD SET SCREW HIGH TENSILE 8.8 ZINC PLATED
0304	M12x60 HEX HEAD SET SCREW HIGH TENSILE 8.8 ZINC PLATED
0305	M12x70 HEX HEAD SET SCREW HIGH TENSILE 8.8 ZINC PLATED
0306	M12x80 HEX HEAD SET SCREW HIGH TENSILE 8.8 ZINC PLATED
0308	M12x100 HEX HEAD SET SCREW HIGH TENSILE 8.8 ZINC PLATED
0320	M16x30 HEX HEAD SET SCREW HIGH TENSILE 8.8 ZINC PLATED
0559	M16x35 HEX HEAD SET SCREW HIGH TENSILE 8.8 ZINC PLATED
0321	M16x40 HEX HEAD SET SCREW HIGH TENSILE 8.8 ZINC PLATED
0322	M16x50 HEX HEAD SET SCREW HIGH TENSILE 8.8 ZINC PLATED
0323	M16x60 HEX HEAD SET SCREW HIGH TENSILE 8.8 ZINC PLATED
0324	M16x70 HEX HEAD SET SCREW HIGH TENSILE 8.8 ZINC PLATED
0325	M16x80 HEX HEAD SET SCREW HIGH TENSILE 8.8 ZINC PLATED
0326	M16x90 HEX HEAD SET SCREW HIGH TENSILE 8.8 ZINC PLATED
0330	M16x45 HEX HEAD SET SCREW HIGH TENSILE 8.8 ZINC PLATED
0335	M20x50 HEX HEAD SET SCREW HIGH TENSILE 8.8 ZINC PLATED
0336	M20x60 HEX HEAD SET SCREW HIGH TENSILE 8.8 ZINC PLATED
0337	M20x70 HEX HEAD SET SCREW HIGH TENSILE 8.8 ZINC PLATED
0338	M20x80 HEX HEAD SET SCREW HIGH TENSILE 8.8 ZINC PLATED
0339	M20x90 HEX HEAD SET SCREW HIGH TENSILE 8.8 ZINC PLATED
0345	M20x55 HEX HEAD SET SCREW HIGH TENSILE 8.8 ZINC PLATED

**HEXAGON HEAD CONE POINTED SET SCREW ZINC PLATED**

0360	M10x40 HEXAGON HEAD CONE POINTED SET SCREW ZINC PLATED
------	--



HEXAGON HEAD COACH SCREW ZINC PLATED

0440	M12x50 HEXAGON HEAD COACH SCREW ZINC PLATED
------	---



HEXAGON HEAD BOLT HIGH TENSILE 8.8 ZINC PLATED

0548	M12x45 HEX HEAD ZINC BOLT ONLY - Grade 8.8 High Tensile
0549	M12x55 HEX HEAD ZINC BOLT ONLY - Grade 8.8 High Tensile
0561	M16x50 HEX HEAD ZINC BOLT ONLY - Grade 8.8 High Tensile
0562	M16x60 HEX HEAD ZINC BOLT ONLY - Grade 8.8 High Tensile
0563	M16x70 HEX HEAD ZINC BOLT ONLY - Grade 8.8 High Tensile

PRODUCT DESCRIPTION  
CODE

0564	M16x80 HEX HEAD ZINC BOLT ONLY - Grade 8.8 High Tensile
0565	M16x90 HEX HEAD ZINC BOLT ONLY - Grade 8.8 High Tensile
0566	M16x100 HEX HEAD ZINC BOLT ONLY - Grade 8.8 High Tensile
0567	M16x110 HEX HEAD ZINC BOLT ONLY - Grade 8.8 High Tensile
0568	M16x120 HEX HEAD ZINC BOLT ONLY - Grade 8.8 High Tensile
0569	M16x130 HEX HEAD ZINC BOLT ONLY - Grade 8.8 High Tensile
0570	M16x140 HEXAGON HEAD BOLT HIGH TENSILE 8.8 ZINC PLATED
0571	M16x150 HEX HEAD ZINC BOLT ONLY - Grade 8.8 High Tensile
0577	M16x45 HEX HEAD ZINC BOLT ONLY - Grade 8.8 High Tensile
0580	M16x55 HEX HEAD ZINC BOLT ONLY - Grade 8.8 High Tensile
0581	M16x65 HEX HEAD ZINC BOLT ONLY - Grade 8.8 High Tensile
0582	M16x75 HEX HEAD ZINC BOLT ONLY - Grade 8.8 High Tensile
0585	M20x85 HEX HEAD ZINC BOLT ONLY - Grade 8.8 High Tensile
0587	M20x65 HEX HEAD ZINC BOLT ONLY - Grade 8.8 High Tensile
0588	M20x55 HEX HEAD ZINC BOLT ONLY - Grade 8.8 High Tensile
0589	M20x45 HEX HEAD SET SCREW HIGH TENSILE 8.8 ZINC PLATED
0590	M20x50 HEX HEAD ZINC BOLT ONLY - Grade 8.8 High Tensile
0591	M20x60 HEX HEAD ZINC BOLT ONLY - Grade 8.8 High Tensile
0592	M20x70 HEX HEAD ZINC BOLT ONLY - Grade 8.8 High Tensile
0593	M20x80 HEX HEAD ZINC BOLT ONLY - Grade 8.8 High Tensile
0594	M20x90 HEX HEAD ZINC BOLT ONLY - Grade 8.8 High Tensile
0595	M20x100 HEX HEAD ZINC BOLT ONLY - Grade 8.8 High Tensile
0596	M20x110 HEX HEAD ZINC BOLT ONLY - Grade 8.8 High Tensile
0598	M20x130 HEX HEAD ZINC BOLT ONLY - Grade 8.8 High Tensile
0599	M20x140 HEX HEAD ZINC BOLT ONLY - Grade 8.8 High Tensile
0600	M20x150 HEX HEAD ZINC BOLT ONLY - Grade 8.8 High Tensile
0602	M20x170 HEX HEAD ZINC BOLT ONLY - Grade 8.8 High Tensile
0612	M20x75 HEX HEAD ZINC BOLT ONLY - Grade 8.8 High Tensile
0620	M24x50 HEXAGON HEAD BOLT HIGH TENSILE 8.8 ZINC PLATED
0621	M24x60 HEX HEAD SET SCREW HIGH TENSILE 8.8 ZINC PLATED
0622	M24x70 HEX HEAD ZINC BOLT ONLY - Grade 8.8 High Tensile
0623	M24x80 HEX HEAD ZINC BOLT ONLY - Grade 8.8 High Tensile
0624	M24x90 HEX HEAD ZINC BOLT ONLY - Grade 8.8 High Tensile
0625	M24x100 HEX HEAD ZINC BOLT ONLY - Grade 8.8 High Tensile
0626	M24x110 HEX HEAD ZINC BOLT ONLY - Grade 8.8 High Tensile
0627	M24x120 HEX HEAD ZINC BOLT ONLY - Grade 8.8 High Tensile
0628	M24x130 HEX HEAD ZINC BOLT ONLY - Grade 8.8 High Tensile
0630	M24x150 HEXAGON HEAD BOLT HIGH TENSILE 8.8 ZINC PLATED
0635	M24x200 HEX HEAD ZINC BOLT ONLY - Grade 8.8 High Tensile
0640	M24x55 HEX HEAD SET SCREW HIGH TENSILE 8.8 ZINC PLATED
0653	M27x120 HEX HEAD ZINC BOLT ONLY - Grade 8.8 High Tensile



BOW NUT

0734	M10 S/C BOW NUT
0735	M12 S/C BOW NUT



LIPPED ANCHOR

1040	M8x30 LIPPED ANCHOR
1041	M10x30 LIPPED ANCHOR
1042	M10x40 LIPPED ANCHOR
1043	M12x50 LIPPED ANCHOR

PRODUCT DESCRIPTION  
CODE



WEDGE NUT



BALL/SWIVEL HANGER

1221	M10 BALL/SWIVEL HANGER
1222	M12 BALL/SWIVEL HANGER



THREADED LINK EYE

1242	M12 THREADED LINK EYE
------	-----------------------



RAWLBOLT

1261	M8 RAWLBOLT
1262	M10 RAWLBOLT
1263	M12 RAWLBOLT
1264	M16 RAWLBOLT



THRU-BOLT

1280	M10x75 THRU-BOLT
1288	M10x120 THRU-BOLT
1292	M12x80 THRU-BOLT
1300	M12x120 THRU-BOLT
1312	M16x150 THRU-BOLT

**PROJECTING BOLT ANCHOR**

1327	M10x105 PROJECTING BOLT ANCHOR (M30 FIXTURE THICKNESS)
------	--

**SPRING TOGGLE**

1380	M10 SPRING TOGGLE
------	-------------------

GENERAL FASTENERS



## MALLEABLE IRON FITTINGS

All product codes are prefixed 1960

MALLEABLE IRON FITTINGS



BLK MALLEABLE IRON SCREW-ON-BRACKET	
5000	8 A501 BLK MALLEABLE IRON SCREW-ON-BRACKET
5001	10 A501 BLK MALLEABLE IRON SCREW-ON-BRACKET
5002	15 A501 BLK MALLEABLE IRON SCREW-ON-BRACKET
5003	20 A501 BLK MALLEABLE IRON SCREW-ON-BRACKET
5004	25 A501 BLK MALLEABLE IRON SCREW-ON-BRACKET
5005	32 A501 BLK MALLEABLE IRON SCREW-ON-BRACKET
5006	40 A501 BLK MALLEABLE IRON SCREW-ON-BRACKET
5007	50 A501 BLK MALLEABLE IRON SCREW-ON-BRACKET
5008	65 A501 BLK MALLEABLE IRON SCREW-ON-BRACKET
5009	80 A501 BLK MALLEABLE IRON SCREW-ON-BRACKET
5010	100 A501 BLK MALLEABLE IRON SCREW-ON-BRACKET

BLK MALLEABLE IRON BACKPLATE	
5051	1/4 BSP A515 BLK MALLEABLE IRON BACKPLATE
5071	M8 METRIC A515M BLK MALLEABLE IRON BACKPLATE
5072	M10 METRIC A515M BLK MALLEABLE IRON BACKPLATE
5073	M12 METRIC A515M BLK MALLEABLE IRON BACKPLATE

BLK MALLEABLE IRON SINGLE PIPE RING	
5103	20 BSP A529 BLK MALLEABLE IRON SINGLE PIPE RING
5122	15 METRIC A529M BLK MALLEABLE IRON SINGLE PIPE RING
5123	20 METRIC A529M BLK MALLEABLE IRON SINGLE PIPE RING
5124	25 METRIC A529M BLK MALLEABLE IRON SINGLE PIPE RING
5125	32 METRIC A529M BLK MALLEABLE IRON SINGLE PIPE RING
5126	40 METRIC A529M BLK MALLEABLE IRON SINGLE PIPE RING
5127	50 METRIC A529M BLK MALLEABLE IRON SINGLE PIPE RING
5128	65 METRIC A529M BLK MALLEABLE IRON SINGLE PIPE RING
5129	80 METRIC A529M BLK MALLEABLE IRON SINGLE PIPE RING
5130	100 METRIC A529M BLK MALLEABLE IRON SINGLE PIPE RING
5131	125 METRIC A529M BLK MALLEABLE IRON SINGLE PIPE RING
5132	150 METRIC A529M BLK MALLEABLE IRON SINGLE PIPE RING

BLK MALLEABLE IRON DOUBLE PIPE RING	
5173	20 METRIC A530M BLK MALLEABLE IRON DOUBLE PIPE RING
5175	32 METRIC A530M BLK MALLEABLE IRON DOUBLE PIPE RING
5176	40 METRIC A530M BLK MALLEABLE IRON DOUBLE PIPE RING
5181	125 METRIC A530M BLK MALLEABLE IRON DOUBLE PIPE RING

GAL MALLEABLE IRON SCREW-ON-BRACKET	
5200	8 A501 GAL MALLEABLE IRON SCREW-ON-BRACKET
5201	10 A501 GAL MALLEABLE IRON SCREW-ON-BRACKET
5202	15 A501 GAL MALLEABLE IRON SCREW-ON-BRACKET
5203	20 A501 GAL MALLEABLE IRON SCREW-ON-BRACKET
5204	25 A501 GAL MALLEABLE IRON SCREW-ON-BRACKET
5205	32 A501 GAL MALLEABLE IRON SCREW-ON-BRACKET
5206	40 A501 GAL MALLEABLE IRON SCREW-ON-BRACKET
5207	50 A501 GAL MALLEABLE IRON SCREW-ON-BRACKET
5208	65 A501 GAL MALLEABLE IRON SCREW-ON-BRACKET
5209	80 A501 GAL MALLEABLE IRON SCREW-ON-BRACKET
5210	100 A501 GAL MALLEABLE IRON SCREW-ON-BRACKET

GAL MALLEABLE IRON BACKPLATE	
5253	1/2 BSP A515 GAL MALLEABLE IRON BACKPLATE
5272	M10 METRIC A515M GAL MALLEABLE IRON BACKPLATE
5273	M12 METRIC A515M GAL MALLEABLE IRON BACKPLATE

BRIGHT ZINC PLATED BACKPLATE	
5280	M8/M10 METRIC BRIGHT ZINC PLATED BACKPLATE - DUAL TAPPED

GAL MALLEABLE IRON SINGLE PIPE RING	
5302	15 BSP A529 GAL MALLEABLE IRON SINGLE PIPE RING
5303	20 BSP A529 GAL MALLEABLE IRON SINGLE PIPE RING
5306	40 BSP A529 GAL MALLEABLE IRON SINGLE PIPE RING
5307	50 BSP A529 GAL MALLEABLE IRON SINGLE PIPE RING
5321	10 METRIC A529M GAL MALLEABLE IRON SINGLE PIPE RING
5322	15 METRIC A529M GAL MALLEABLE IRON SINGLE PIPE RING
5323	20 METRIC A529M GAL MALLEABLE IRON SINGLE PIPE RING
5324	25 METRIC A529M GAL MALLEABLE IRON SINGLE PIPE RING
5325	32 METRIC A529M GAL MALLEABLE IRON SINGLE PIPE RING
5326	40 METRIC A529M GAL MALLEABLE IRON SINGLE PIPE RING
5327	50 METRIC A529M GAL MALLEABLE IRON SINGLE PIPE RING
5328	65 METRIC A529M GAL MALLEABLE IRON SINGLE PIPE RING
5329	80 METRIC A529M GAL MALLEABLE IRON SINGLE PIPE RING
5330	100 METRIC A529M GAL MALLEABLE IRON SINGLE PIPE RING
5331	125 METRIC A529M GAL MALLEABLE IRON SINGLE PIPE RING
5332	150 METRIC A529M GAL MALLEABLE IRON SINGLE PIPE RING

GAL MALLEABLE IRON DOUBLE PIPE RING	
5372	15 METRIC A530M GAL MALLEABLE IRON DOUBLE PIPE RING
5373	20 METRIC A530M GAL MALLEABLE IRON DOUBLE PIPE RING
5374	25 METRIC A530M GAL MALLEABLE IRON DOUBLE PIPE RING
5376	40 METRIC A530M GAL MALLEABLE IRON DOUBLE PIPE RING

## BRASS FITTINGS

All product codes are prefixed 1960

BRASS FITTINGS



BRASS HOSPITAL BRACKET	
6024	42 A622 BRASS HOSPITAL BRACKET

PRESSED BRASS SCREW ON BRACKET	
6050	15 A623 PRESSED BRASS SCREW ON BRACKET
6051	22 A623 PRESSED BRASS SCREW ON BRACKET

PRESSED BRASS SCREW ON CHROME PLTD BRACKET	
6060	15 A623CP PRESSED BRASS SCREW ON BRACKET CHROME PLTD
6061	22 A623CP PRESSED BRASS SCREW ON BRACKET CHROME PLTD
6062	28 A623CP PRESSED BRASS SCREW ON BRACKET CHROME PLTD

CAST BRASS SCREW ON BRACKET	
6080	15 A624 CAST BRASS SCREW ON BRACKET

CAST BRASS SCREW ON CHROME PLTD BRACKET	
6081	22 A624 CAST BRASS SCREW ON BRACKET
6082	28 A624 CAST BRASS SCREW ON BRACKET
6083	35 A624 CAST BRASS SCREW ON BRACKET
6085	54 A624 CAST BRASS SCREW ON BRACKET

BRASS SINGLE RING METRIC	
6161	15xM10 A632 BRASS SINGLE RING METRIC
6162	22xM10 A632 BRASS SINGLE RING METRIC
6163	28xM10 A632 BRASS SINGLE RING METRIC
6164	35xM10 A632 BRASS SINGLE RING METRIC

BRASS SINGLE RING METRIC CHROME PLTD	
6181	15xM10 A632CP BRASS SINGLE RING METRIC CHROME PLTD
6182	22xM10 A632CP BRASS SINGLE RING METRIC CHROME PLTD
6183	28xM10 A632CP BRASS SINGLE RING METRIC CHROME PLTD
6184	35xM10 A632CP BRASS SINGLE RING METRIC CHROME PLTD
6185	42xM10 A632CP BRASS SINGLE RING METRIC CHROME PLTD
6186	54xM10 A632CP BRASS SINGLE RING METRIC CHROME PLTD

BRASS DOUBLE RING METRIC	
6242	28xM10 A636 BRASS DOUBLE RING METRIC

METRIC BRASS FEM BACKPLATE	
6276	M10 METRIC THREAD A640 BRASS FEM BACKPLATE

METRIC BRASS FEM BACKPLATE CHROME PLTD	
6296	M10 METRIC THREAD A640CP BRASS FEM BACKPLATE CHROME PLTD

METRIC BRASS MALE BACKPLATE	
6314	M10 METRIC THREAD A641 BRASS MALE BACKPLATE

METRIC BRASS MALE BACKPLATE CHROME PLTD	
6334	M10 METRIC THREAD A641CP BRASS MALE BACKPLATE CHROME PLTD

## FIRE PROTECTION



FIRE COLLARS



ACRYLIC MASTIC



FIRE SLEEVES



COLLAR INSTALLATION



PUTTY CORD



FIRE WRAPS



FIRE PILLOWS

FIRE PROTECTION

## FLAT ROOF SUPPORT SYSTEMS



FLAT ROOF SUPPORT



## PIPE & DRAINAGE SYSTEMS, VALVES, BRACKETRY & ASSOCIATED PRODUCTS

### CARBON STEEL PIPE SYSTEMS



### COPPER PIPE SYSTEMS



### STAINLESS STEEL PIPE SYSTEMS



### DRAINAGE SYSTEMS



### PLASTIC PIPE SYSTEMS



### INDUSTRIAL PIPE SYSTEMS



### VALVES & CONTROLS



### PIPE SUPPORT SYSTEMS



PIPE & DRAINAGE SYSTEMS, VALVES, BRACKETRY & ASSOCIATED PRODUCTS



**ALBION** [albionvalves.uk](http://albionvalves.uk)

**AQUATHERM** [aquatherm.com](http://aquatherm.com)

**CONEX BANNINGER** [conexbanninger.com](http://conexbanninger.com)

**CRANE** [cranefs.com](http://cranefs.com)

**GEBERIT** [geberit.co.uk](http://geberit.co.uk)

**GEORGE FISCHER** [georgfischer.com](http://georgfischer.com)

**HATTERSLEY** [hattersley.com](http://hattersley.com)

**PEGLER** [peglyorkshire.co.uk](http://peglyorkshire.co.uk)

**POLYPIPE** [polypipe.com](http://polypipe.com)

**SAINT GOBAIN** [saint-gobain-pam.co.uk](http://saint-gobain-pam.co.uk)

**TATA STEEL** [tatasteelurope.com](http://tatasteelurope.com)

**VICTAULIC** [victaulic.com](http://victaulic.com)

**WEDNESBURY** [wednesburytube.com](http://wednesburytube.com)

**WILO** [wilo.com](http://wilo.com)



# BRANCHES

## NORTH WEST

Mill Hill Street,  
Bolton, Greater Manchester,  
BL2 2AB  
T: 0161 967 0400

## MIDLANDS

Block 5, Grazebrook Ind Est  
Peartree Lane  
Dudley  
DY2 0XW  
T: 01384 986400

## SOUTH WEST

Unit 9, Oak Lane, Fishponds  
Trading Estate, Bristol BS5  
7UY  
T: 0117 961 7000

## SOUTH EAST

Neptune Way,  
Medway City Estate,  
Rochester  
Kent ME2 4NA  
T: 01634 566 860



[Enquiries@Ashworth.uk.com](mailto:Enquiries@Ashworth.uk.com)



[Ashworth.uk.com](http://Ashworth.uk.com)

**SPECIALIST DISTRIBUTORS OF  
COMMERCIAL HEATING, PLUMBING  
& DRAINAGE SOLUTIONS**



# ASHWORTH

PEOPLE - PRODUCTS - SERVICE

